

# ***Artificial Intelligence***

Sebastian Iwanowski  
FH Wedel, University of Applied Sciences

## **chapter 7:** Ant Algorithms

### **7.2:** Application to Dynamic Road Navigation

concepts partially elaborated in master thesis of Thomas Walther, 2006 (in German)

# System Design: System components

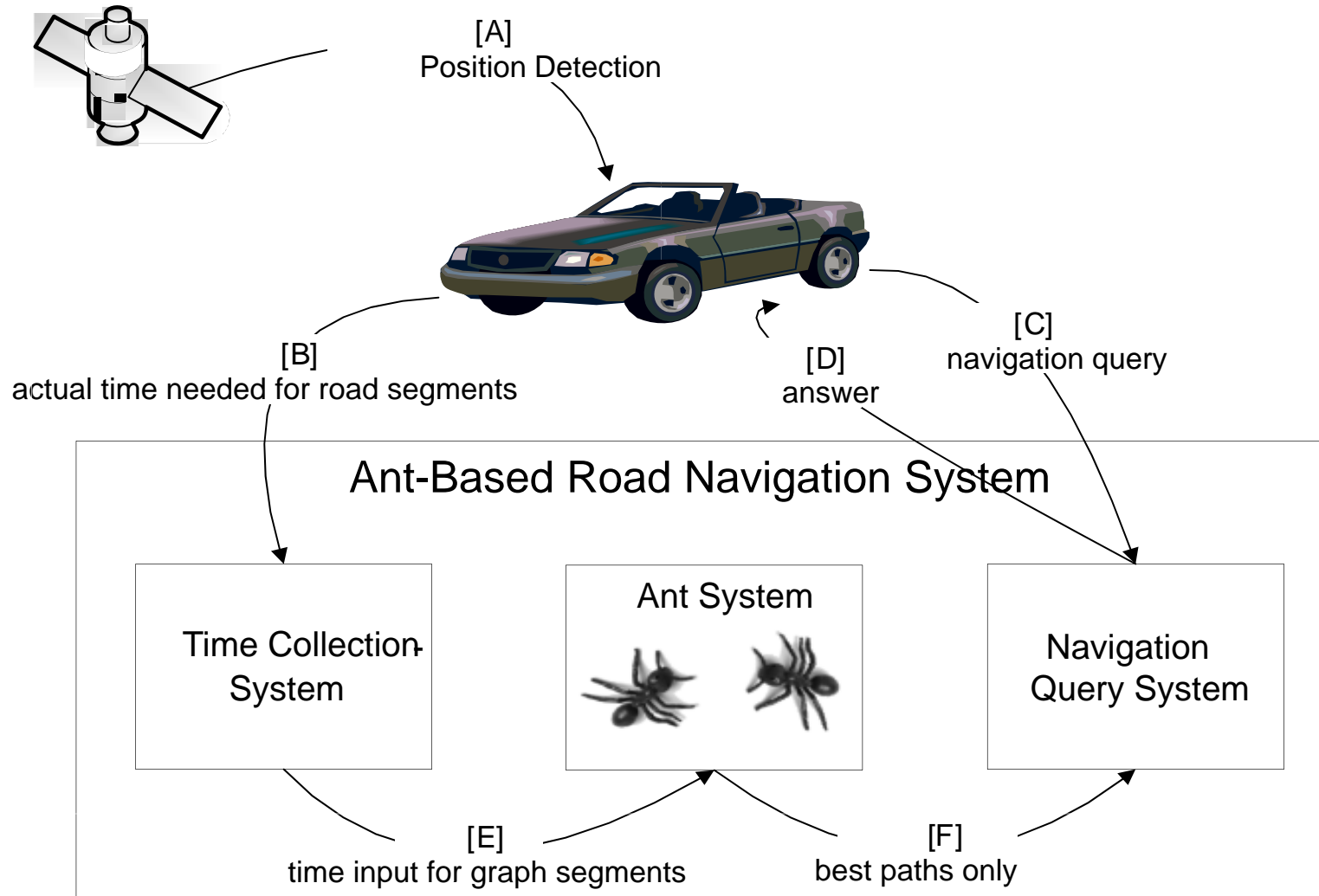

# System Design: System components

## Time Collection System

- Maintains actual situation for the entire road system
- Various data sources: Induction loops, cameras, vehicles, ...

## Vehicles as data sources:

- Needs overall detection
- Is problematic with little traffic density
- Only average time is stored (referring to a time window)

# System Design: Distribution of system components

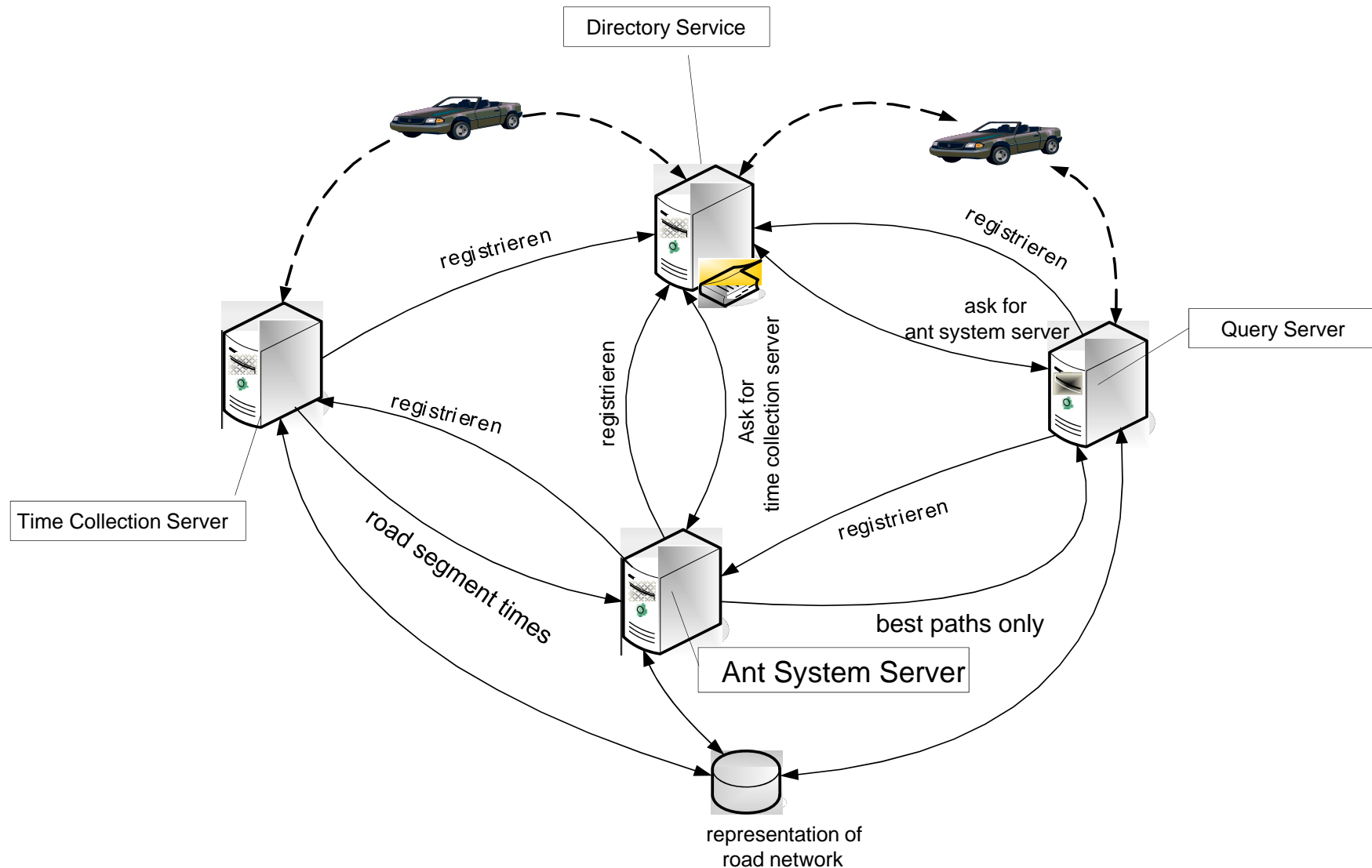

# System Design: Distributing the ant system

## Big networks are a problem:

- Amount of ants grows quadratic in network size
- More ants produce a higher computing effort

## Solution:

- Distribute computing load to several peer services
- This is enabled by indirect and local communication

# System Design: Distributing the ant system

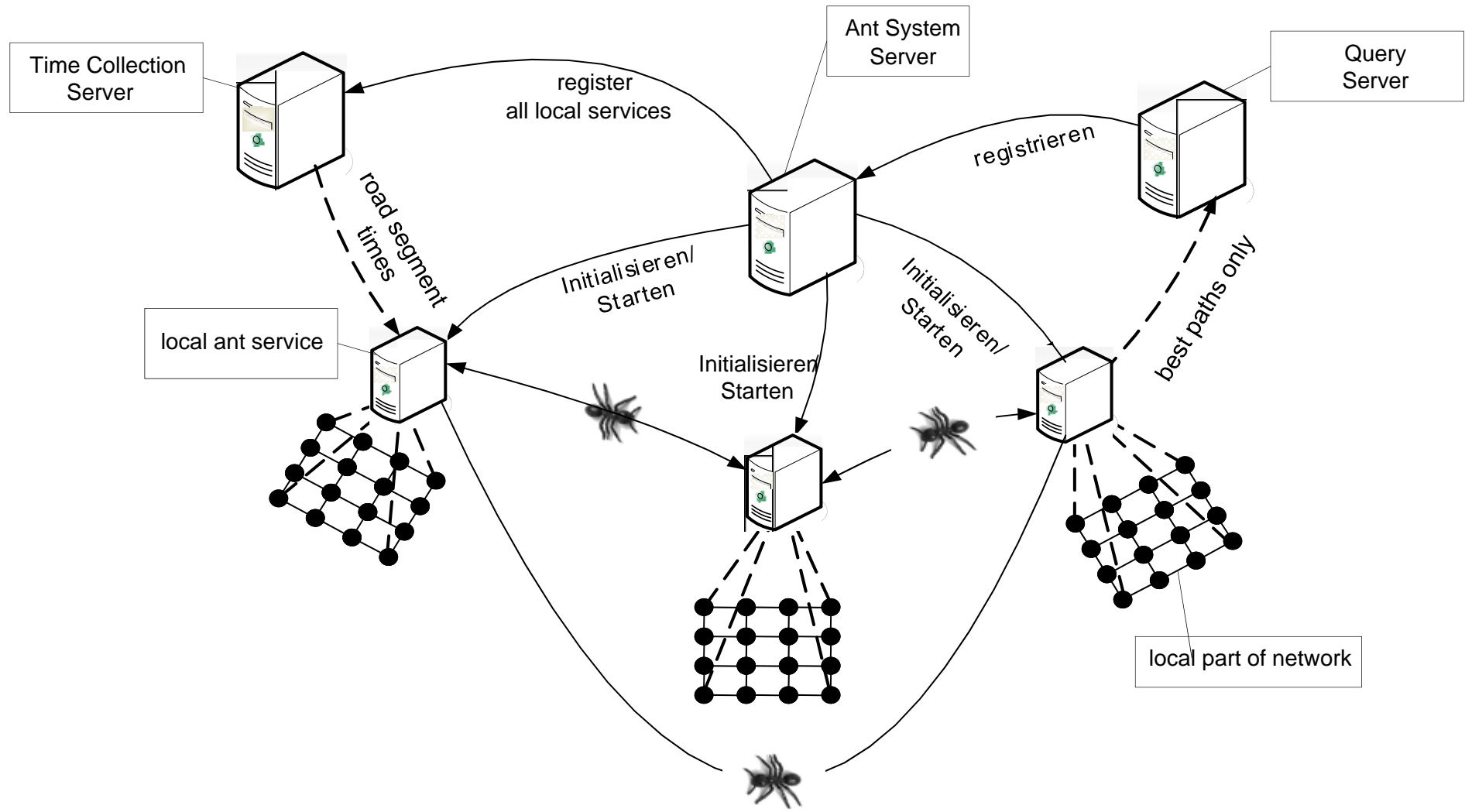

# Mobile use of pheromones

There the ant algorithm is performed.

Pheromones of respective zone are distributed to all vehicles residing in respective zone.

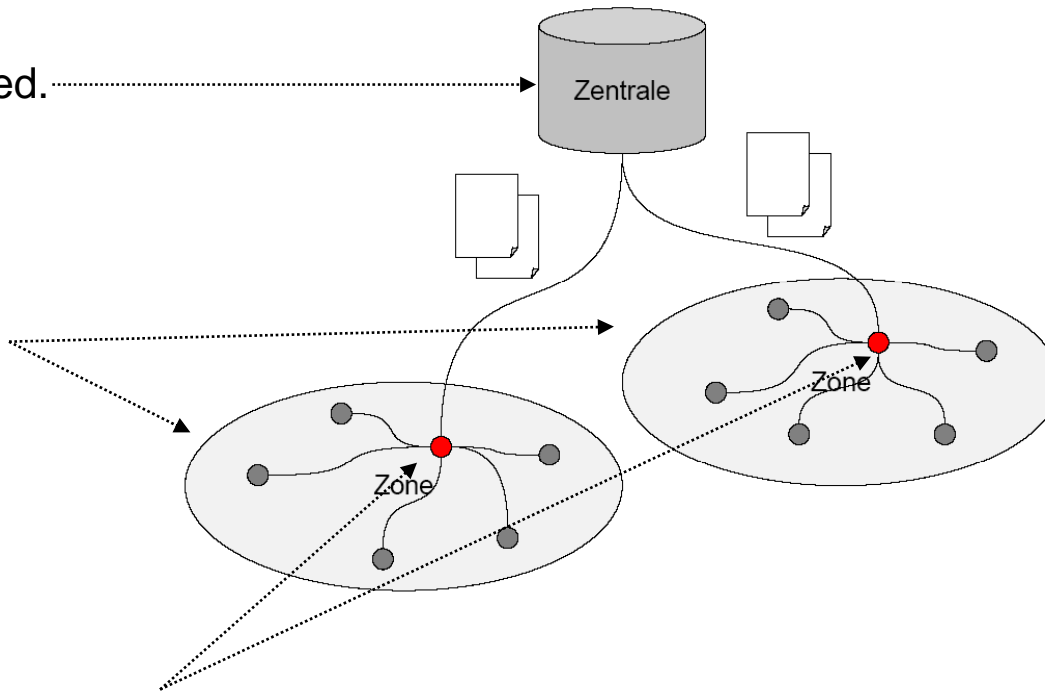

Only very few vehicles ask directly at central server.

discussion und details in master thesis of Michael Suthe, 2007 (in German)

# Advantages to traditional navigation methods

## Compressed storage of data:

- Pheromones store compressed information collected from many segments.
- This enables feasible mobile distribution.

## Concurrent computation of data:

- Ant system computes pheromones off-board.
- This enables greater computing capacities.
- **Eager computing before actual query → quicker reply.**

## Middleware connecting data collection and data use:

- Dynamic data is collected from all of the country and distributed to each user.
- Central server is mediator between data collectors and data users.
- This grants the general advantage of each middleware:  
Less communication effort between providers and users.



# Ant Colony Optimization (ACO)

## Developments by several research groups

### AntNet

Dorigo M., G. Di Caro & L. M. Gambardella (1999). Ant Algorithms for Discrete Optimization. *Artificial Life*, 5(2):137-172.

<http://iridia.ulb.ac.be/~mdorigo/ACO/ACO.html>

Gianni Di Caro, An Introduction to Swarm Intelligence and Metaheuristics for Combinatorial Optimization: lecture slides [http://www.idsia.ch/~gianni/my\\_lectures.html](http://www.idsia.ch/~gianni/my_lectures.html)

### Ant Based Control (ABC)

Kroon R., *Dynamic vehicle routing using Ant Based Control*, Master's thesis, Delft University of Technology, 2002.

R. Schoonderwoerd, O. Holland, and J. Bruten. Ant-like agents for load balancing in telecommunications networks. In *Proceedings of the First International Conference on Autonomous Agents*, pages 209–216. ACM Press, 1997.

# Ant Colony Optimization (ACO)

Base for path decision:

Routing table for each node

Examples for nodes F and C:

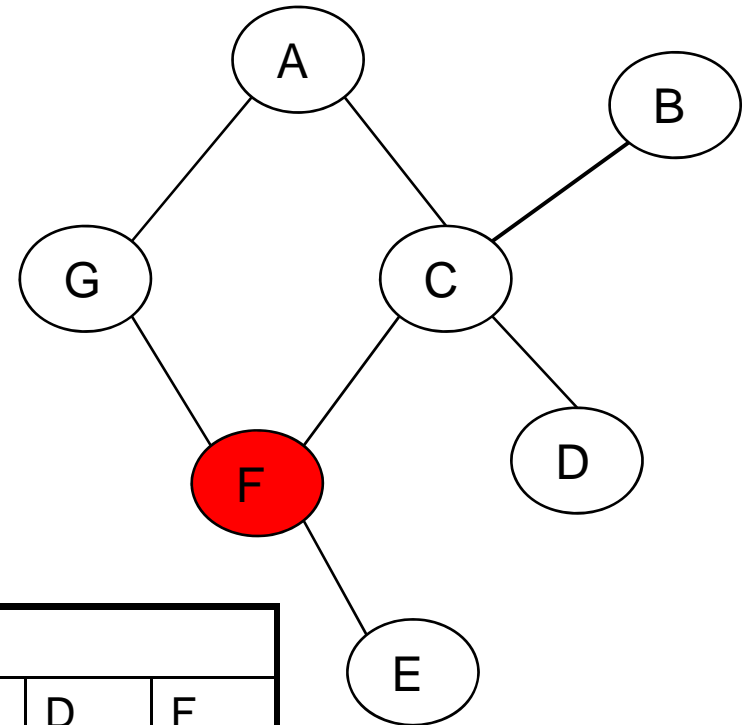

table F				
Next \ Dest	C	G	E	
A	0.3	0.65	0.05	
B	0.5	0.35	0.15	
C	0.9	0.05	0.05	
D	0.9	0.05	0.05	
E	0.05	0.05	0.9	
G	0.6	0.35	0.05	

table C					
Next \ Dest	A	B	D	F	
A	0.7	0.1	0.1	0.1	
B	0.05	0.85	0.05	0.05	
D	0.05	0.05	0.85	0.05	
E	0.25	0.05	0.05	0.65	
F	0.15	0.05	0.05	0.75	
G	0.6	0.05	0.05	0.3	

# Ant Colony Optimization (ACO)

## Algorithmic processing

### Forward and backward ants

Continuous generation of forward ants from each source to each destination

Tasks of a forward ant:

- At each intersection, choose next edge probabilistically (according current table entries)
- Collect and store the encountered information (edge lengths, etc.)
- Start a backward ant when destination is reached

Tasks of a backward ant:

- Trace back the path the corresponding forward ant used
- Update node infos according to information collected by respective forward ant

## Details of a specific ACO procedure (ABC)

$$\Delta P_{s,d} = \frac{c_1}{t_{s,d}} + c_2$$

Evaporation coefficient:

This number is used to confirm the path, the forward ant has used, and – simultaneously – to diminish the paths, the forward ant has NOT used.

### Evaporation of pheromones

$$P_{d,i} = \frac{P_{d,i}}{1 + \Delta P_{s,d}} \quad \forall i \neq f$$

### Confirmation of pheromones

$$P_{d,f} = \frac{P_{d,f} + \Delta P_{s,d}}{1 + \Delta P_{s,d}}$$

s ... source of forward ant

d ... destination of forward ant

F ... node which was next for forward ant in order to reach destination

# Example for a specific ACO procedure (ABC)

## Behaviour of forward ant

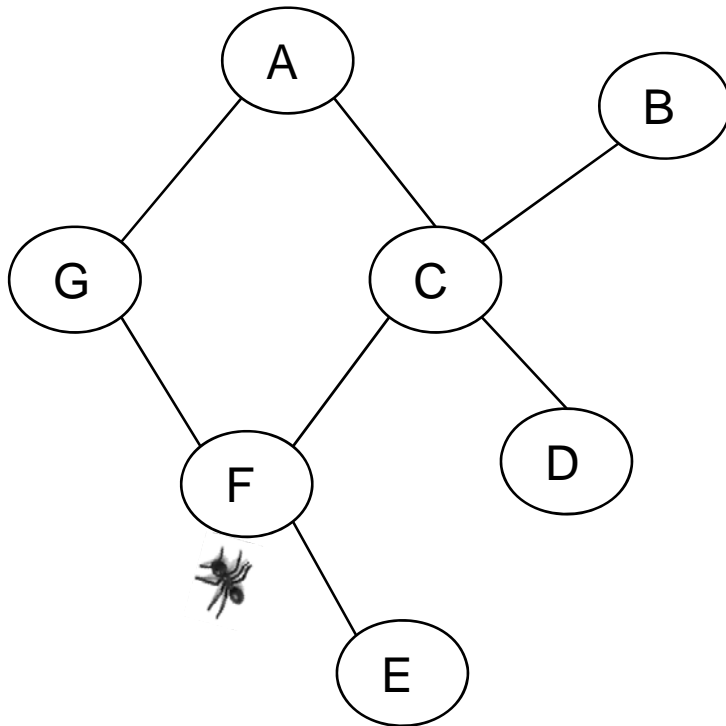

memory  
 $s = F \quad d = B$   
 $t_{F,C} = 0,5 \quad t_{C,B} = 1,5$

Table for F (extract)

Next \ Dest	C	G	E
B	0.5	0.35	0.15

Table for C (extract)

Next \ Dest	A	B	D	F
B	0.05	0.85	0.05	0.05

# Example for a specific ACO procedure (ABC)

## Behaviour of forward ant

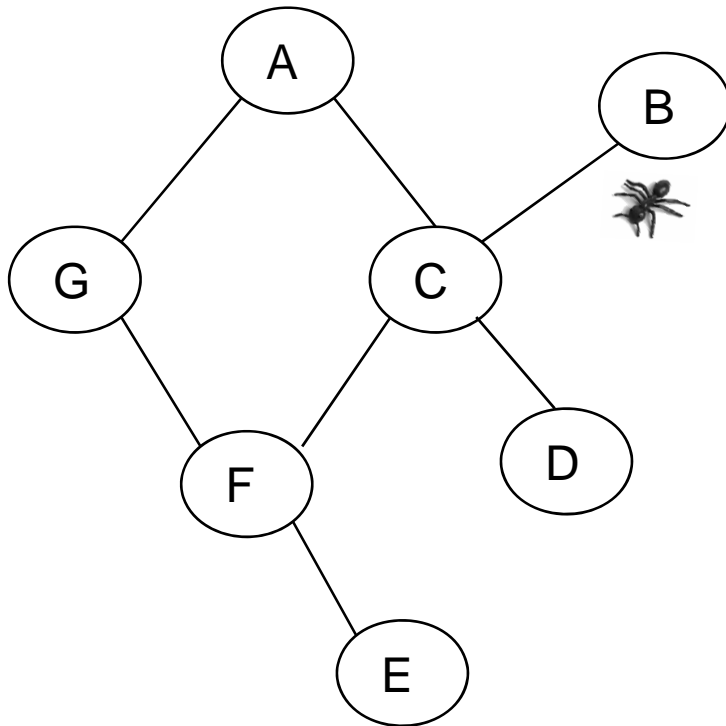

memory  
 $s = F \quad d = B$   
 $t_{F,C}=0,5 \quad t_{C,B}=1,5$

Table for C (extract)

Next \ Dest	A	B	D	F
B	0.05	0.85	0.05	0.05

Update does not change any entry for C, because the minimum value must be 0.05.

# Example for a specific ACO procedure (ABC)

## Behaviour of backward ant

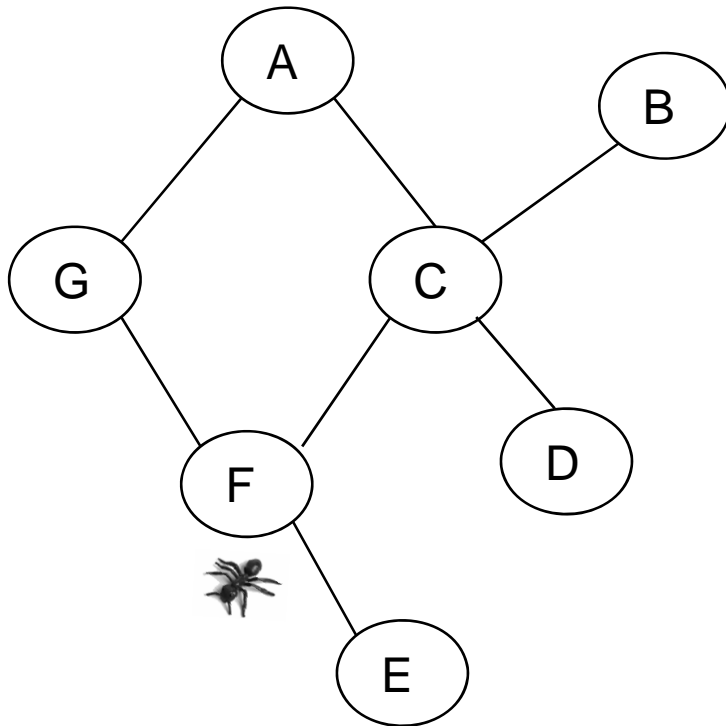

<u>memory</u>	
s = F	d = B
$t_{F,C}=0,5$	$t_{C,B}=1,5$

$$t_{F,B} = 2$$

Old Table for F (extract)				
Next \ Dest	C	G	E	
B	0.5	0.35	0.15	

New Table for F (extract)				
Next \ Dest	C	G	E	
B	0.83	0.12	0.05	

$$\Delta P = \frac{2}{2} + 1$$

$$P_{\text{new},C} = \frac{0.5 + 2}{1 + 2} = 0,83$$

$$P_{\text{new},G} = \frac{0.35}{1 + 2} = 0,12$$

$$P_{\text{new},E} = \frac{0.15}{1 + 2} = 0,05$$